

PL4-HS User Manual V1.1

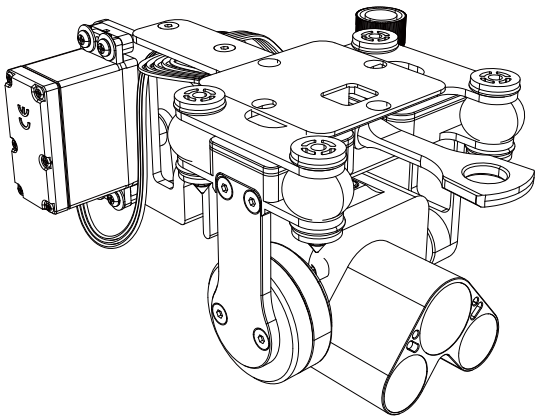

PL4-HS – Low light payload release for SplashDrone 3+. For low-light and night-time payload release, the PL4 utilizes a high-sensitivity sensor and dual LED spotlights to return colour HD images in near darkness. Get live as well as recorded video footage from the drone and accurately locate your target zone at night before remotely dropping your baits. Add the optional burley dry chum release system takes your night fishing to the next level.

Contents

Installation	03
Operation	04
Gimbal Camera Control	04
Payload Release Control	04
Camera	04
Install Micro SD Card	04
Button Indication	05
Camera Display	05

1. Installation

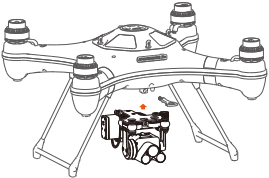
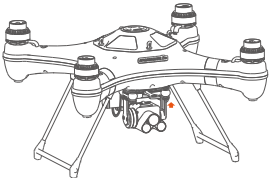
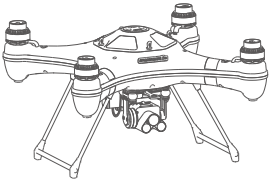
Illustration	Description
	<p>1. Remove the quick-release screw from the mounting plate.</p>
	<p>2. Mount the gimbal, with the camera facing the front of the drone onto the quick release plate and secure it with the quick-release screw.</p>
	<p>3. Insert the data cable connector into the socket in the correct direction, and tighten the waterproof ring.</p>
	<p>4. Installation complete.</p>

2. Remote Control

Gimbal and camera control

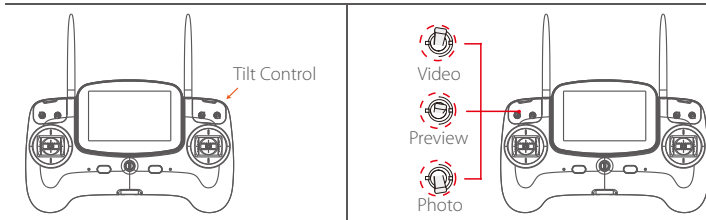

Payload Release Control

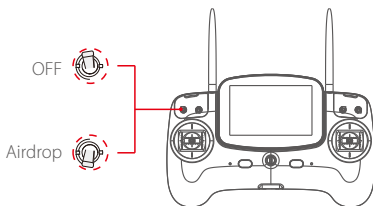

3. Camera

PL4 camera comes with a high sensitive sensor and a LED fill light, allows capturing color HD images even in the dark.

Install Micro SD card

1. Open the soft rubber sealing plug at the top of the camera, install the Micro SD card in correct direction.
2. Refasten the rubber plug firmly to ensure a good seal.

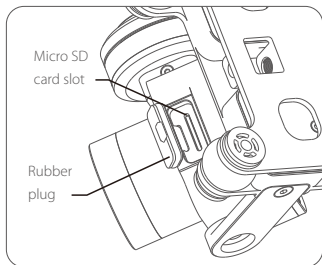

- ⚠ 1. The SwellPro PL4 camera supports Micro SD cards with a maximum capacity of 64GB. When selecting a Micro SD card for use with your camera, for best results always ensure that the card is rated for 4K video throughput Class 10 or UHS-1 or better.
- ⚠ 2. After installing the SD card, please fasten the rubber plug firmly to avoid water damage.

Button operation

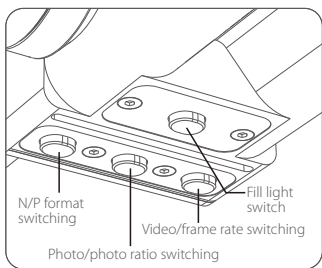

Fill light switch: Short press to turn it ON/OFF

N/P format switching: Long press to switch NTSC/PAL video format

Photo/photo ratio switching: Short press to take a photo, long press to switch the photo ratio 16:9/4:3

Video/frame rate switching: Short press to start recording, long press to switch video frame rate

Camera display

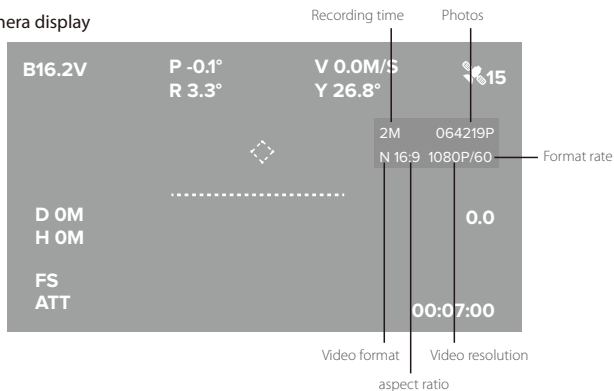

3. Version Information

SwellPro products are constantly being improved. Therefore, although the latest version of this manual may contain information relating to a release of the equipment different from your own, new information is added constantly which is relevant to ALL customers.

Version	Comments
1.0	Pre-release Manual for PL4
1.1	New Manual for PL4